

# Li L9 | Configuration

● Standard - N/A

2024  
Li L9 Pro

2024  
Li L9 Ultra

## Technical Specification

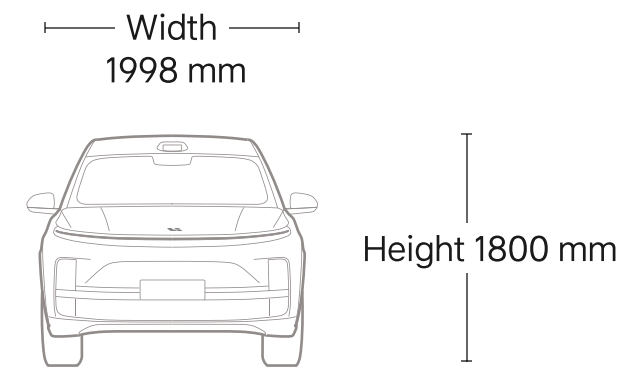
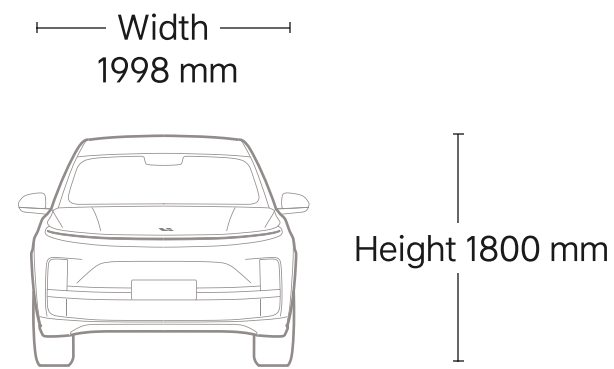

Length 5218 mm

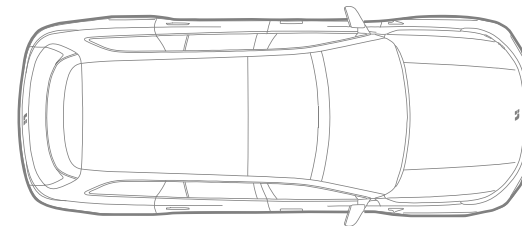

Length 5218 mm

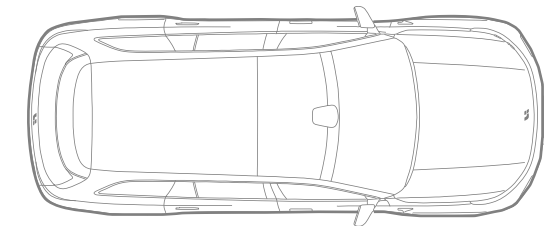

Wheelbase 3105 mm

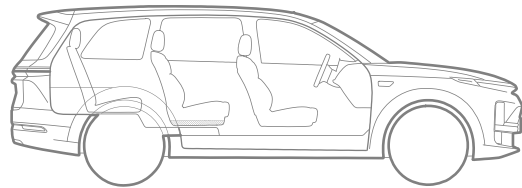

Wheelbase 3105 mm

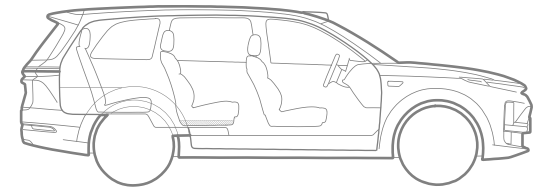

Second Row:  
Headroom 1034 mm, Maximum  
Legroom 1071 mm.  
Third Row:  
Headroom 925mm, Maximum  
Legroom 799mm.

Second Row:  
Headroom 1034 mm, Maximum  
Legroom 1071 mm.  
Third Row:  
Headroom 925mm, Maximum  
Legroom 799mm.

Length	5218mm	5218mm
Width	1998mm	1998mm
Height	1800mm	1800mm
Wheelbase	3105mm	3105mm
Passenger capacity	6	6
Seat layout	2-2-2	2-2-2
CLTC range under comprehensive working conditions	1412km	1412km

# Li L9 | Configuration

● Standard - N/A

2024  
Li L9 Pro

2024  
Li L9 Ultra

## Exterior Color and Interior Upholstery



### Paint color

 Golden Metallic	●	●
 Silver Metallic	●	●
 Gray Metallic	●	●
 Black Metallic	●	●
 Deep Green - Special Edition Pearl	+RMB 10,000	+RMB 10,000
 Purple Light - Special Edition Pearl	+RMB 10,000	+RMB 10,000

### Wheels

21" Silver-Grey Wheels (With 265/45 R21 Silent Tires)	●	●
21" Black-Grey Wheels (With 265/45 R21 Silent Tires)	●	●

### Interior Upholstery color

 Black & White	●	●
 Black & Orange	●	●
 Dynamic Black interior upholstery	●	●

● Standard - N/A

2024  
Li L9 Pro

2024  
Li L9 Ultra

## Extended Platform

### Range Extended EV

Traction battery	52.3kWh Ternary lithium battery	52.3kWh Ternary lithium battery
Range Extender	1.5T Four-Cylinder	1.5T Four-Cylinder
CLTC range under comprehensive working conditions	1412km	1412km
WLTC range under comprehensive working conditions	1176km	1176km
CLTC battery life under comprehensive working conditions	280km	280km
WLTC battery life under comprehensive working conditions	235km	235km
DC charging time (Typical charging duration)	25 minutes (20%-80%)	25 minutes (20%-80%)
AC slow-charging time (7kW)	7.9 hours (0-100%)	7.9 hours (0-100%)
External discharge	3.5kW	3.5kW
Fuel tank capacity	65L	65L
Fuel type	95	95
Environmental standard	China VIB	China VIB
Energy Modes	Electric / Fuel / Hybrid	Electric / Fuel / Hybrid
<b>Power</b>		
Drive system	Front and Rear Motor 4WD	Front and Rear Motor 4WD
Total power of power system	330kW	330kW
Total torque of power system	620N·m	620N·m
0-100km/h acceleration time	5.3s	5.3s

# Li L9 | Configuration

● Standard - N/A

2024

**Li L9 Pro**

2024

**Li L9 Ultra**

Maximum speed

180km/h (electronic speed control)

180km/h (electronic speed control)

5-in-1 front drive system

Power: 130 kW  
Torque: 220 N·m

Power: 130 kW  
Torque: 220 N·m

3-in-1 rear drive system

Power: 200 kW  
Torque: 400 N·m

Power: 200 kW  
Torque: 400 N·m

Power Mode

Comfort, Standard, Sport,  
Performance

Comfort, Standard, Sport,  
Performance

## Chassis

Front suspension type

Double wishbone front suspension

Double wishbone front suspension

Rear suspension type

Five-link rear suspension

Five-link rear suspension

Magic Carpet Air Suspension

Magic Carpet Air Suspension Max

Magic Carpet Air Suspension Max

Dual-chamber air springs

●

●

Continuous damping control

●

●

Automatic speed-dependent adjustment of vehicle height

Lower by 20 mm

Lower by 20 mm

Effortless Entry and Exit

Lower by 40 mm

Lower by 40 mm

Convenient trunk loading mode

Lower by 50 mm

Lower by 50 mm

Tough road modes

Conquer Off-road Obstacles (suspension is automatically raised by 40mm), slippery road mode, and hill descent control

Conquer Off-road Obstacles (suspension is automatically raised by 40mm), slippery road mode, and hill descent control

Variable speed EPS

●

●

Regenerative braking system

Comfort, Standard, Strong

Comfort, Standard, Strong

Ventilated front & rear disc brakes

●

●

Electronic braking assistance

●

●

## Comfort and Luxury Features

Seats



# Li L9 | Configuration

● Standard - N/A

2024  
Li L9 Pro

2024  
Li L9 Ultra

## First row seats

Nappa leather seats	●	●
Comfortable sponge	●	●
Comfortable soft headrests	x2	x2
Ventilated seats	●	●
Heated seats	●	●
Electric seats	●	●
Spa-grade 16-point massage (10 points at back + 6 points in cushion)	●	●
Seat memory	●	●
Magic Carpet driver seat (with smart cushion firmness adjustment)	●	●
Boss button for the front passenger seat	●	●

## Second row seats

Nappa leather seats	●	●
Comfortable sponge	●	●
Comfortable soft headrests	x2	x2
Ventilated seats	●	●
Heated seats	●	●
Heated leg rest	Right seat	Right seat
Electric seats	●	●
Spa-grade 16-point massage (10 points at back + 6 points in cushion)	●	●
Right-side queen seat	Electric foot rest Electric leg rest Seat tilt angle	Electric foot rest Electric leg rest Seat tilt angle

# Li L9 | Configuration

● Standard - N/A

2024  
Li L9 Pro

2024  
Li L9 Ultra

Fold-out table on the right



One-tap reset of seats



Queen Seat Mode



Inside armrest with stepless adjustment



## Third row seats

Comfortable sponge



Heated seats



Electric seats



One-button electric folding



One-button electric unfolding



## Comfort Cockpit Features

Platinum Audio System



Smart warmer/refrigerator  
(with electric control)



Tri-zone smart climate control with air  
purification (with CO2 sensor)



Rear independent air vents

The second and third rows

The second and third rows

Fragrance (three options)



PM2.5 monitoring



Air quality system (AQS)



Negative ion generator



Steering wheel heating



Steering wheel 4-way automatic control



LED interior ambient lights (256 colors)



# Li L9 | Configuration

● Standard - N/A

2024  
Li L9 Pro

2024  
Li L9 Ultra

LED touch reading lights for the first, second, and third rows



LED floor lights

The first and second rows

The first and second rows

Sun visor vanity mirror

With LED lighting

With LED lighting

Two-pane panoramic sunroof electric sunshade



One-touch button to lift and lower all windows (with anti-pinch)



Nap Mode



Bed Mode



## Cabin material

Premium black fabric lining



Nappa leather multi-function steering wheel



Double-layer, silver-plated heat insulating windshield



Double-layer, sound insulating glass in the first row



Double-layer, sound insulating and tinted glass in the second row



Tinted glass in the third row



Two-pane panoramic sunroof  
(Double-layered noise and heat insulating glass)



Anti-UV glass for the whole vehicle



Tufted mats for the whole vehicle



## Interior Charging

Front-row wireless mobile phone charging  
(50W air cooling)

×2

×2

Front-row USB Type-C (15W)

×2

×2

# Li L9 | Configuration

● Standard - N/A

2024  
Li L9 Pro

2024  
Li L9 Ultra

Second-row USB Type-C (60W)

×2

×2

Third-row USB Type-C (15W)

×2

×2

Interior 220V socket

2.2kW

2.2kW

Interior 12V Socket

Front row ×1, Trunk ×1

Front row ×1, Trunk ×1

## Storage Space

Front-row independent cup holder

×2

×2

Second-row independent cup holder

×2

×2

Third-row independent cup holder

×2

×2

Front-row lower storage space

●

●

Split armrest box

●

●

Super-large door storage space

●

●

Hidden trunk storage space

●

●

## Convenient Driving and Riding

Keyless entry

Four doors

Four doors

Keyless start

●

●

Mobile phone Bluetooth key

●

●

Remote vehicle control with App

●

●

Smart vehicle finder

With automatic parking lot  
photographing

With automatic parking lot  
photographing

Smart key

×2

×2

Mechanical key

×1

×1

Power column shift

●

●

Flush door handles for the whole vehicle

●

●

Electric suction doors for the whole vehicle

●

●

# Li L9 | Configuration

● Standard - N/A

## 2024 Li L9 Pro

## 2024 Li L9 Ultra

Electric tailgate sensor	●	●
Electric tailgate position memory	Steplessly adjustable	Steplessly adjustable
Electric heating for side mirrors	●	●
Integrated side mirror blind spot detection	●	●
Electric adjustment of side mirrors (with side mirror memory)	●	●
Automatic side mirror adjustment for reversing	●	●
Automatic anti-glare rearview mirror	●	●
Automatic anti-glare driver side mirror	●	●
360° HD panoramic camera	●	●
Transparent chassis	●	●
HD reversing camera	●	●
On-board electric pump	●	●
On-board tool kit	●	●

## Smart Driving

### Li Pilot Assistance AD Pro

### Li Pilot Assistance AD Max

## Li AD Max Smart Driving Hardware Platform

Domain controller	Horizon Robotics Journey™ 5 ×1 (128TOPS)	NVIDIA Orin-X ×2 (508TOPS)
128-line LiDAR	-	●
Front perception camera	8 MP ×1	8 MP ×2
Side front perception camera	2 MP ×2	8 MP ×2
Side rear perception camera	2 MP ×2	8 MP ×2
Rear perception camera	2 MP ×1	2 MP ×1

# Li L9 | Configuration

● Standard - N/A

2024  
Li L9 Pro

2024  
Li L9 Ultra

Surround view camera

3 MP ×4

3 MP ×4

Forward millimeter wave radar

●

●

Ultrasonic radar

×12

×12

Capacitive hand detection steering wheel

●

●

Steering wheel with vibration alert

●

●

Attention Warning System

●

●

## All-Scenario NOA

Highways as well as urban beltways and roads across China

Passing urban intersections

(going straight/unprotected left and right turns)

-

●

Detour on urban roads

(construction/obstacle vehicles)

-

●

Lane change in traffic jams

(highways/urban roads)

Only Highways

●

Lane change and overtaking

(autonomous/recommended)

●

●

Ramp entry and exit

(highways/urban roads)

Only Highways

●

Speed limit control

(highways/urban roads)

Only Highways

●

## All-Scenario LCC

Highways as well as urban beltways and roads across China

Passing intersections in response to traffic lights (going straight)\*

●

●

Detour on urban roads\*

●

●

Roadwork deceleration & avoidance\*

●

●

Autonomous lane selection at merge/diverge junctions\*

●

●

# Li L9 | Configuration

● Standard - N/A

2024  
Li L9 Pro

2024  
Li L9 Ultra

Autonomous inference and lane line generation\*

●

●

Lane Keep Assist (LKA)

●

●

Lane change in response to turn signals

●

●

\*2024 Li L9 Pro will be released via OTA in the future

## Intelligent parking

360° panoramic camera

●

●

Auto Park Assist (APA)

Space parking (basic version)/Straight-line remote control

Space parking (basic version)/Straight-line remote control

Remote Parking (RPA)

●

●

Remote Parking Out (RPO)\*

●

●

Automatic Valet Parking (AVP)

-

Silent route learning/Cross-floor channel driving/Reversing adjustment/Avoidance & detour

Functions marked with \* will be released via OTA in the future

Functions marked with \* will be released via OTA in the future

## Active Safety

Autonomous Emergency brake

●

●

General Obstacles-Autonomous Emergency brake\*

-

●

Rear-Autonomous Emergency brake\*

-

●

Maneuver-Autonomous Emergency brake\*

-

●

Autonomous Emergency Steering\*

-

●

Front Crossing Traffic Assist /Brake\*

-

Warning/Brake

Rear Crossing Traffic Assist /Brake\*

-

Warning/Brake

Emergency Lane Keeping

●

●



# Li L9 | Configuration

● Standard - N/A

2024  
Li L9 Pro

2024  
Li L9 Ultra

MissAcceleration Inhabit\*

-

●

Lane Departure Prevention

●

●

Lane Departure Warning

●

●

Front Collision Warning

●

●

Rear Collision Warning\*

-

●

Door Opening Warning

●

●

Traffic Sign Recognition

●

●

Traffic Light Recognition\*

-

●

Traffic Speed Assist\*

-

●

Functions marked with \* will be released via OTA in the future

Functions marked with \* will be released via OTA in the future

## Smart Space

Li Smart Space SS Ultra

Li Smart Space SS Ultra

### Li AD Max Smart Driving Hardware Platform

HMI Chips

Qualcomm Snapdragon 8295P High Performance Edition

Qualcomm Snapdragon 8295P High Performance Edition

RAM

32GB

32GB

High-speed dual-SIM 5G module

●

●

Steering Wheel Safe Driving Touch-Bar Display

●

●

HD projection heads up display (HUD)

●

●

15.7-inch Center Information Display (CID)  
(3K resolution)

●

●

15.7-inch Copilot Entertainment Display  
(3K resolution)

●

●

# Li L9 | Configuration

● Standard - N/A

2024  
Li L9 Pro

2024  
Li L9 Ultra

15.7-inch Rear Entertainment Display  
(3K resolution)



A-SPICE anti-shatter glass



Anti-glare screen technology



Dual array microphone

6 groups

6 groups

Cockpit Sensor

RGB&IR Visual module ×2

RGB&IR Visual module ×2

Speaker/Power

21 Speakers/2160 W

21 Speakers/2160 W

Second-row 4D vibration units



## AI Li Xiang Tong Xue

Large model Mind GPT-based Li Xiang Tong Xue



Multimodal wireless conversation zone positioning



Multimodal voice control for any displayed voice assistant command options

Voice and visual fusion search

Voice and visual fusion search

Multimodal anaphora interaction  
(voice/gesture)



Voiceprint recognition and following



Continuous execution of multi-task command



Free Interaction with Dialects



Offline voice support



Whole-vehicle Wakeup-free



## HMI System

Card UI desktop



Children Mode



# Li L9 | Configuration

● Standard - N/A

2024  
Li L9 Pro

2024  
Li L9 Ultra

Multi-screen simultaneous casting



TaskFlex



Tuning Master



Painting Master



Magic camera



Browser



Vehicle hotspot\*



## App Store

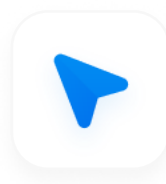

Map



iQIYI

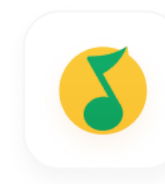

QQ  
Music



Netease  
Cloud Music



bilibili



Himalaya

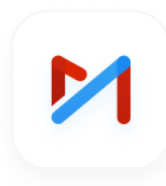

Migu Video

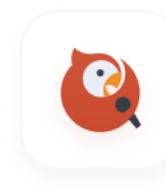

WeSing

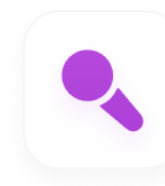

Leishi KTV



Tencent  
Video

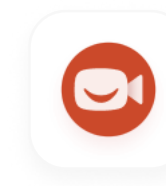

Huanxi  
Premium

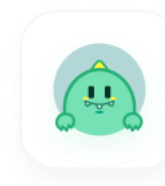

Idiom chain



Uncle Kai  
stories



CITIC  
Academy



Dedao



Meituan

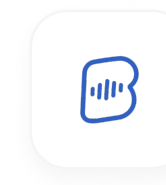

LIZHI  
Podcast

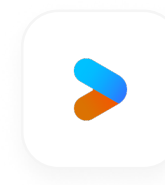

Youku  
Video

Ongoing OTA upgrades

Functions marked with \* will be released via OTA in the future

Functions marked with \* will be released via OTA in the future

## Flagship Video

Dolby Atmos



Dolby Vision



7.3.4 speaker layout



Speaker/Power

21 Speakers/2160 W

21 Speakers/2160 W

# Li L9 | Configuration

● Standard - N/A

## 2024 Li L9 Pro

## 2024 Li L9 Ultra

Tweeter design	Dual edge aluminum cone	Dual edge aluminum cone
Mid-range speaker design	CosCone	CosCone
Subwoofer Design	CosCone	CosCone
Second-row 4D vibration units	●	●
Screen type (CID/Copilot Entertainment Display)	Gen4 OLED	Gen4 OLED
Screen type (Rear Entertainment Display)	Gen4 OLED	Gen4 OLED
TÜV low blue light certificated	●	●
Eye protection dimming	●	●
Rear Entertainment Display with Electric Opening, Closing and Angle Adjustment	●	●
Multi-touch screen	●	●
Anti-glare screen	●	●
Anti-glare screen technology	●	●
Wired screen casting	Front & rear (3K resolution)	Front & rear (3K resolution)
Wireless screen casting*	●	●
	Functions marked with * will be released via OTA in the future	Functions marked with * will be released via OTA in the future

## Exterior Configuration

### Exterior Lights and Gears

Run-through Halo LED headlights	●	●
3-dimensional Halo LED taillights	●	●
Adaptive LED headlights	●	●
LED low-speed steering assist lights	●	●
LED smart driving assist lights	-	●

# Li L9 | Configuration

● Standard - N/A

2024  
Li L9 Pro

2024  
Li L9 Ultra

LED side marker lights

●

●

LED greeting lights

●

●

LED courtesy lights

●

●

Adaptive headlight height adjustment

●

●

Automatic high beam

●

●

Rain-sensing front wipers

●

●

Concealed rear window wiper

●

●

Mounting holes for roof rack

●

●

Active air-intake grille

●

●

Power Footboards

+RMB 10,000

●

## Charging and Power Supply

Electric charging port flap (Electric induction)

Electric induction

Electric induction

Home charging station

7kW

7kW

Li Auto Home Charging scheduled charging

●

●

Li Supercharging plug-and-charge

●

●

External discharge

3.5kW

3.5kW

External discharge adapter

●

●

## Security Configuration

High-strength steel-aluminum body

●

●

Double-impact protected battery pack

●

●

Front-row front airbag

×2

×2

Front-row side airbag

×2

×2

Second-row side airbag

×2

×2

# Li L9 | Configuration

● Standard - N/A

2024  
Li L9 Pro

2024  
Li L9 Ultra

Curtain airbags for all windows

×2

×2

Dual-chamber far-side airbags

●

●

Pretensioning seatbelt

●

●

ISOFIX interface for child safety seat at the second row

×2

×2

ISOFIX interface for child safety seat at the third row

×2

×2

Electronic child safety locks for rear doors

●

●

Driving recorder

●

●

Hill descent control (HDC)

●

●

Electronic stability program (ESP)

●

●

Tire-pressure monitoring system (TPMS)

●

●

Electronic parking brake (EPB)

●

●

AUTO HOLD parking control

●

●

Pedestrian warning noise

●

●

Electronic anti-theft function for power system

●

●

Trailer mode

●

●

Anti-theft alarm system (remote alert via App)

●

●

Sentry mode

●

●

## Warranty and Services

Vehicle warranty

For 5 years or 100,000 km

For 5 years or 100,000 km

Limited warranty for battery, motor, and electric control system

For 8 years or 160,000 km

For 8 years or 160,000 km

Air suspension warranty

For 8 years or 160,000 km

For 8 years or 160,000 km

# Li L9 | Configuration

● Standard - N/A

## 2024 Li L9 Pro

## 2024 Li L9 Ultra

### Mobile data

Three-year data worry-free solution  
(20 GB of free 5G data per month)

Three-year data worry-free solution  
(20 GB of free 5G data per month)

### 24/7 roadside assistance service

In-Warranty Period

In-Warranty Period

### Free home charging station and basic installation service



### Smart maintenance reminder



### Smart emergency call and rescue



### 24/7 online service agents



#### Tips:

The range and charging time are affected by driving habits, natural environment, battery life and other objective factors. The parameter configuration information is for reference only. For the purpose of design and use safety, Li Auto has the right to adjust the parameters and configuration within the scope of laws and regulations. The specific parameters and configuration are subject to the actual vehicle for sale.

The driving assistance system is an assisting function and cannot cope with all traffic, weather and road conditions. The driver should take active control of the vehicle at all times. Take caution when using this function in complex traffic conditions, on wet, slippery, water-logged or muddy roads, in poor visibility, on rugged mountain terrain or at highway entrances and exits.

The Nappa leather covers the perforated area of the seat cushion and backrest.

The English version is for reference only. In case of any discrepancy, the Chinese version shall prevail.